

**PREDINSTALACIJA
PREDINSTALACIJA**

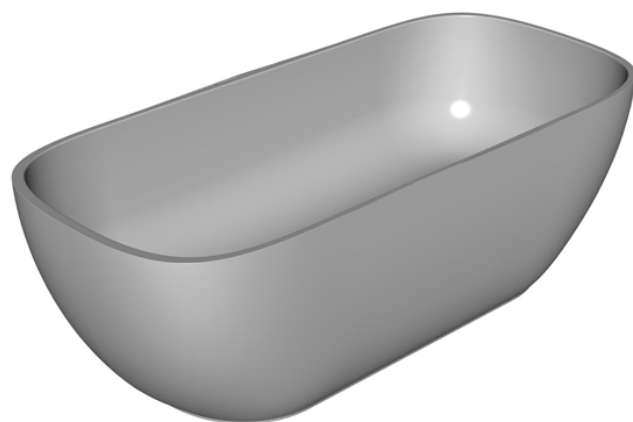
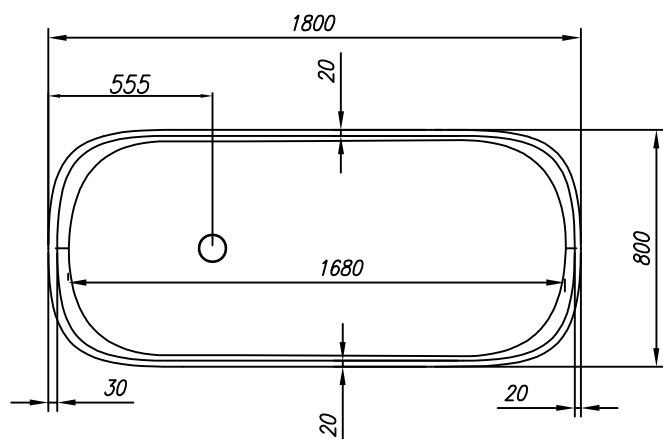
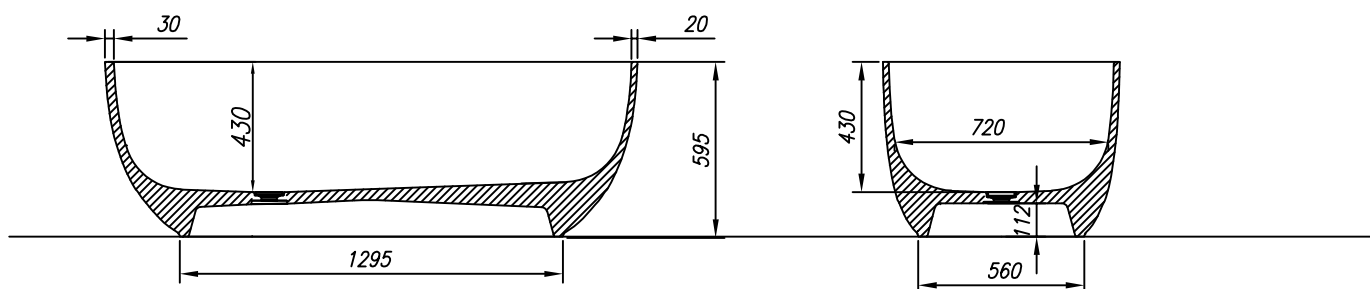
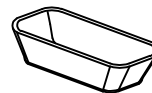

VOLUMEN (l)
VOLUMEN (l)

MAX. OBREMENITEV (kg)
MAX. OBTEREČENJE (kg)

OBREMENITEV TAL (kg/m²)
OBTEREČENJE PODA (kg/m²)

340

720

550

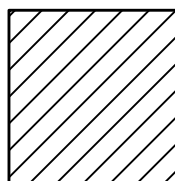

- Prostor za odtok \varnothing 50 mm
- Mjesto za odtok \varnothing 50 mm

PREDLOG VGRADNJE
PRIJEDLOG UGRADNJE

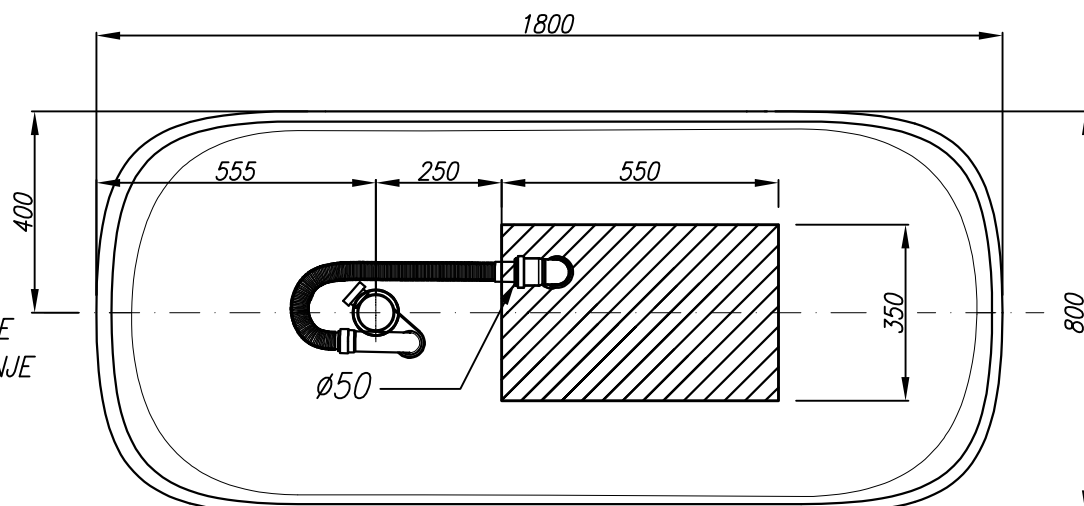

Kopalna kad iz KERROCK-a, FS – samostoječa.
Kada za kupanje iz KERROCK-a, FS – samostoječa.